

A clearer view for glass solutions

***Showers
and
Accessories***



Contents

Showers

QA	Inward bi-fold doors	3
QB	Outward bi-fold doors	4
QC	Inward door glass to wall	5
QD	Inward door glass to glass	6
QE	Outward door glass to wall	7
QF	Outward door glass to glass	8
QG	Pentagon with single inward opening door	9
QH	Pentagon with single outward opening door	10
QJ	Pentagon with double inward opening doors	11
QK	Pentagon with double outward opening doors	12
QL	Quadrant with double inward opening door	13
QM	Quadrant with double outward opening doors	14
QN	Quadrant with single outward opening doors	15

Baths

QP	Single outward opening screen	16
QQ	Single inward opening screen	17
QR	One fixed and one outward opening screen	18
QS	Inward opening bi-fold screen	19
QT	Outward opening bi-fold screen	20
QV	One fixed and one inward opening screen	21

Accessories & Notes

Brackets	22
Hinges	23
Knobs	25
Metal profiles	27
Seals	28
Stabilisers	29
Material and surface finishes available	32
Terms and conditions	31
Notes	33

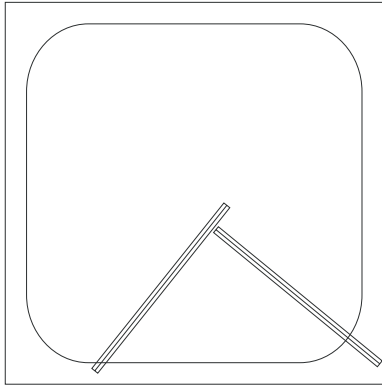

**SHOWER -
Type QA**

Inward opening bi-fold doors to overall width of up to 1200mm

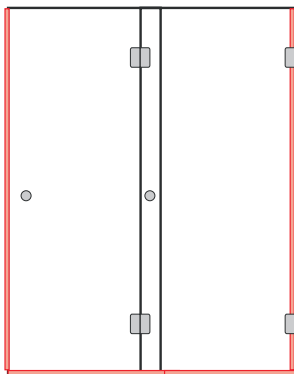
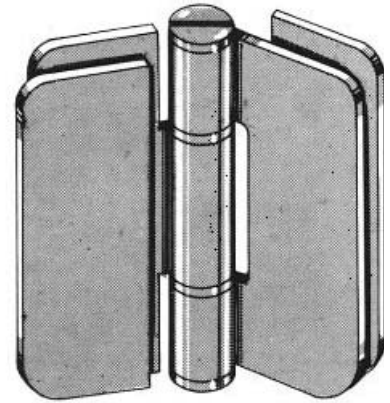

Standard configuration for 8mm glass

- 2 x 50.0001.-- Glass to glass inward opening hinge
- 2 x 50.0003.-- Wall to glass hinge
- 2 x 50.0244.HLF.-- Single sided knob
- 2 x 51.650135.40 Vertical seal at ends
- 1 x 51.636021.40 vertical seal at overlap
- 1 x 650145.40 Soft 'h' seal at threshold

Seal options

- 51.650135.40 Clear bubble
- 51.636021 Right angle blade
- 43.PCSL08.40 threshold seal
- 51.650145.40 soft 'h' seal



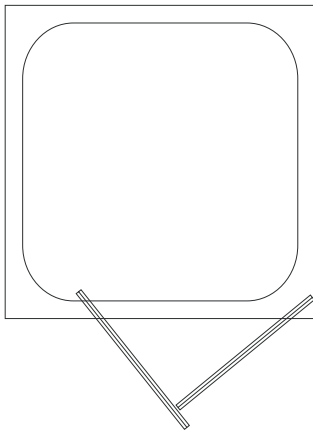

SHOWER - Type QB

Outward opening bi-fold doors
to overall width of up to
1200mm

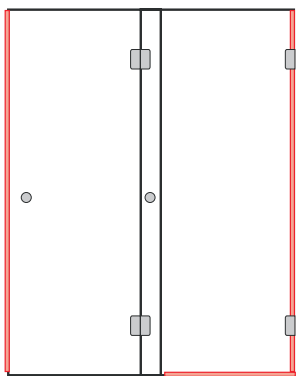
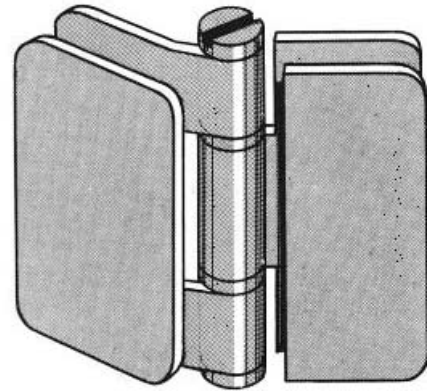

Standard configuration for 8mm glass

2 x 50.0002.--	Glass to glass outward opening hinge
2 x 50.0005.--	Wall to glass hinge
2 x 50.0244.HLF.--	Single sided knob
2 x 51.650135.40	Vertical seal at ends
1 x 51.636021.40	vertical seal at overlap
1 x 650145.40	Soft 'h' seal at threshold

Seal options

51.650135.40	Clear bubble
51.636021	Right angle blade
43.PCSL08.40	threshold seal
51.650145.40	soft 'h' seal



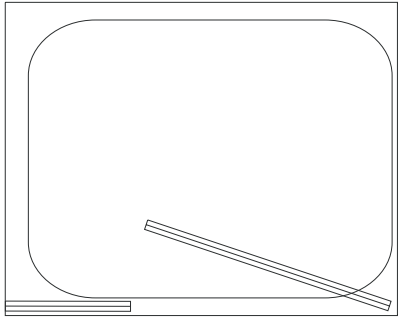

**SHOWER -
Type QC**

Inward opening door to overall width of up to 1200mm

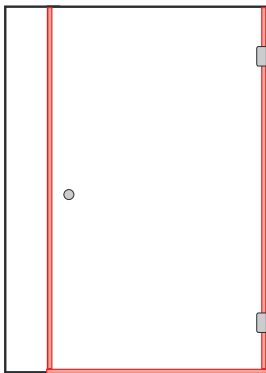
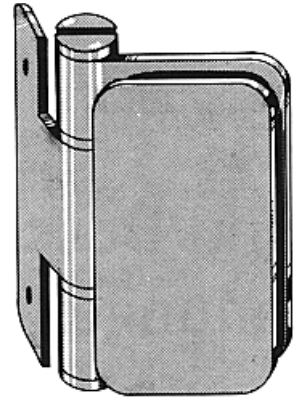

Standard configuration for 8mm glass

- 2 x 50.0003.-- Wall to glass inward opening hinge
- 1 x 50.0244.-- Knob
- 1 x 51.650135.40 Vertical seal hinge edge
- 1 x 51.650.145.40 vertical seal leading edge
- 1 x 43.PCSL08.40 Threshold seal

OR 2m x 50.71.-- 'U' channel set onto wall
2m x 43.UCT12.-- 'U' channel set onto wall

Seal options



51.650135.40 Clear bubble



51.636021 Right angle blade



43.PCSL08.40 threshold seal



51.650145.40 soft 'h' seal



51.636394.40 clear stop seal

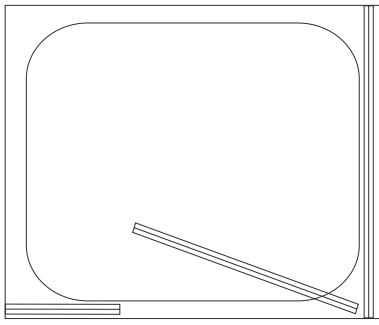

SHOWER - Type QD

Inward opening door to overall width of up to 1200mm

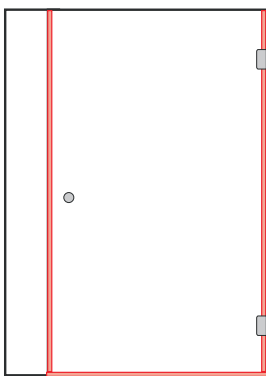
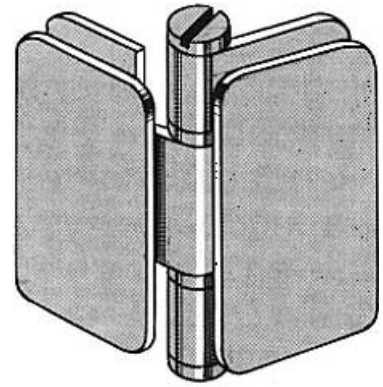

Standard configuration for 8mm glass

2 x 50.0004.--	Glass to glass inward opening hinge
1 x 50.0244.--	Knob
1 x 51.650135.40	Vertical seal hinge edge
1 x 51.650.145.40	vertical seal leading edge
1 x 43.PCSL08.40	Threshold seal

OR 2m x 50.71.-- 'U' channel set onto wall
2m x 43.UCT12.-- 'U' channel set onto wall

Seal options

51.650135.40 Clear bubble

51.636021 Right angle blade

43.PCSL08.40 threshold seal

51.650145.40 soft 'h' seal



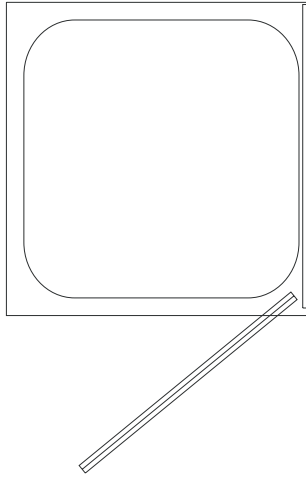

SHOWER - Type QE

Outward opening door to
overall width of up to 1200mm

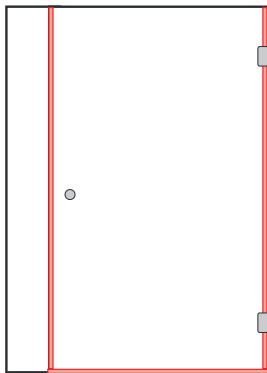
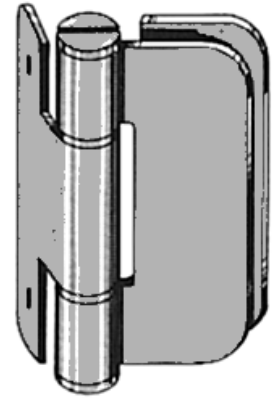

Standard configuration for 8mm glass

2 x 50.0005.--	Wall to glass outward opening hinge
1 x 50.0244.--	Knob
2 x 51.650135.40	Vertical seal hinge edge
1 x 43.PCSL08.40	Threshold seal

Seal options

51.650135.40	Clear bubble
51.636021	Right angle blade
43.PCSL08.40	threshold seal
51.650145.40	soft 'h' seal



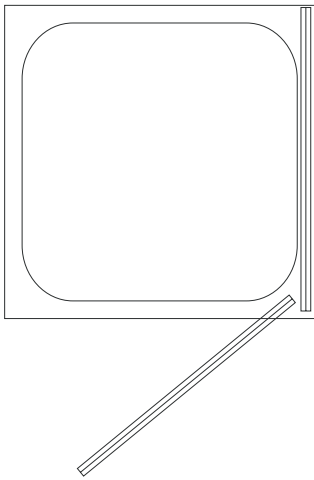

SHOWER - Type QF

Outward opening door to
overall width of up to 1200mm

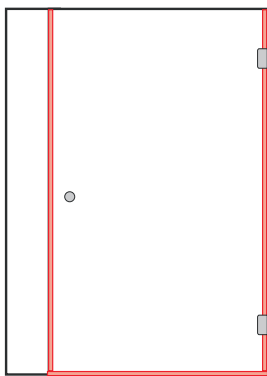
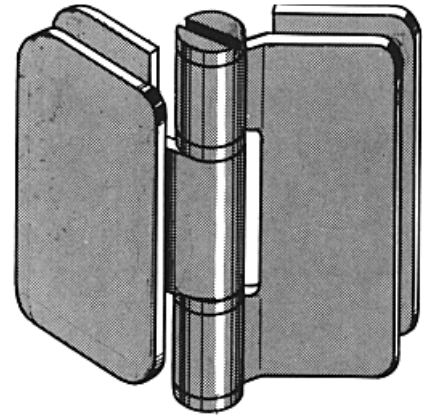

Standard configuration for 8mm glass

2 x 50.0006.-- Glass to glass inward opening hinge

1 x 50.0244.-- Knob

2 x 51.650135.40 Vertical seals

1 x 43.PCSL08.40 Threshold seal

OR 2m x 50.71.-- 'U' channel set onto wall
2m x 43.UCT12.-- 'U' channel set onto wall

Seal options

51.650135.40 Clear bubble

51.636021 Right angle blade

43.PCSL08.40 threshold seal

51.650145.40 soft 'h' seal



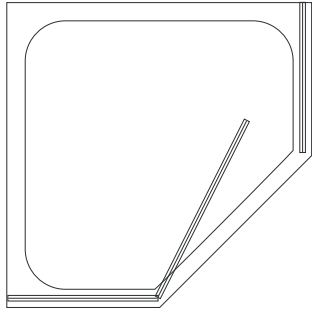

**SHOWER -
Type QG**

Pentagon with inward opening door

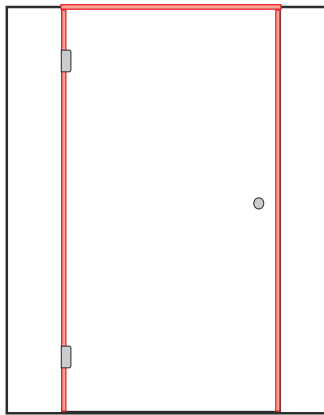
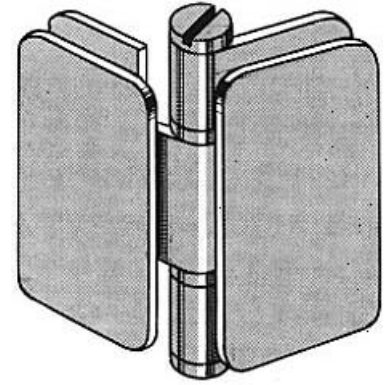

Standard configuration for 8mm glass

2 x 50.0004.135.--	Glass to glass 135° inward opening hinge
1 x 50.0244.--	Knob
1 x 51.650135.40	Vertical seal hinge edge
1 x 50.0401.0303.40	vertical seal leading edge
1 x 43.PCSL08.40	Threshold seal
4 x 50.0012.--	Wall to glass brackets

Seal options

51.650135.40	Clear bubble
51.636021	Right angle blade
43.PCSL08.40	threshold seal
51.650145.40	soft 'h' seal
50.0401.0303.45.40	2 part seal with 22mm 45° blade



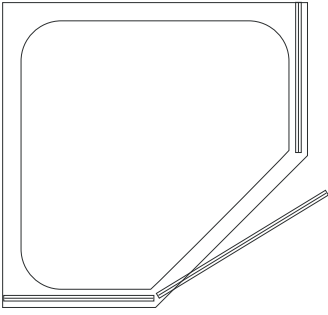

SHOWER - Type QH

Pentagon with outward opening
door

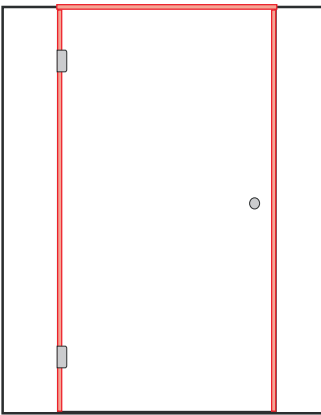
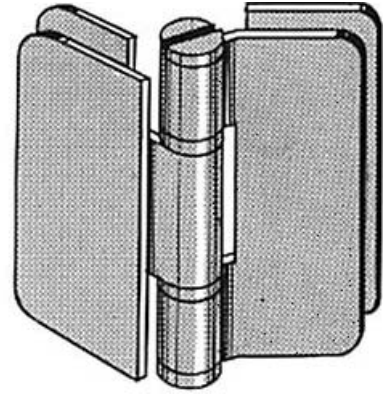

Standard configuration for 8mm glass

2 x 50.0106.--	Glass to glass 135° outward opening hinge
1 x 50.0244.--	Knob
2 x 50.0401.0303.45.40	vertical seals
1 x 43.PCSL08.40	Threshold seal
4 x 50.0012.--	Wall to glass brackets

Seal options

51.650135.40	Clear bubble
51.636021	Right angle blade
43.PCSL08.40	threshold seal
51.650145.40	soft 'h' seal
50.0401.0303.45.40	2 part seal with 22mm 45° blade



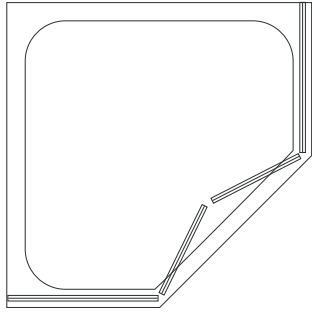

**SHOWER -
Type QJ**

**Pentagon with double inward
opening door**

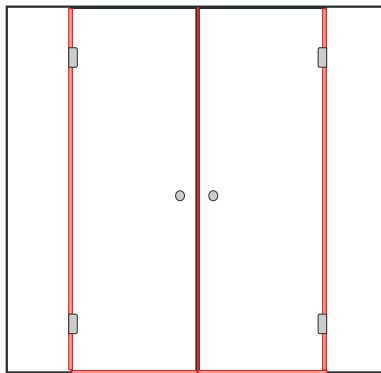
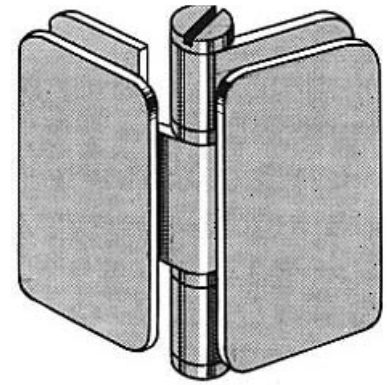

Standard configuration for 8mm glass

- 4 x 50.0004.135.-- Glass to glass 135° inward opening hinge
- 2 x 50.0244.-- Knob
- 2 x 51.650135.40 Vertical seal hinge edge
- 2 x 51.650145.40 1 vertical seal at meeting edges
1 seal for threshold
- 4 x 50.0012.-- Wall to glass brackets

Seal options

- 51.650135.40 Clear bubble
- 51.636021 Right angle blade
- 43.PCSL08.40 threshold seal
- 51.650145.40 soft 'h' seal



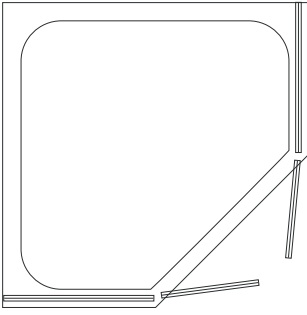

SHOWER - Type QK

Pentagon with double outward
opening door

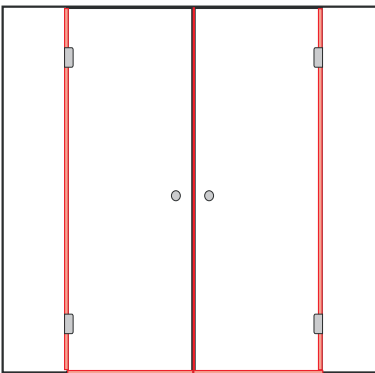
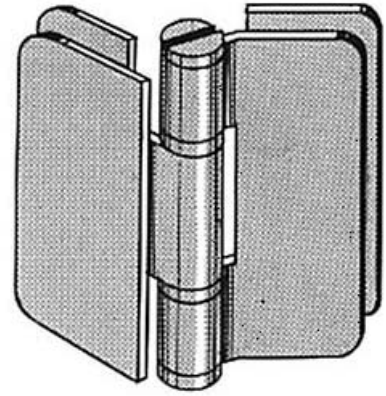

Standard configuration for 8mm glass

4 x 50.0106.--	Glass to glass 135° inward opening hinge
2 x 50.0244.--	Knob
1 x 51.650135.40	Vertical seal meeting edge
2 x 50.0401.0303.40	vertical seal hinge edges
1 x 43.PCSL08.40	Threshold seal
4 x 50.0012.--	Wall to glass brackets

Seal options

51.650135.40	Clear bubble
51.636021	Right angle blade
43.PCSL08.40	threshold seal
51.650145.40	soft 'h' seal
50.0401.0303.45.40	2 part seal with 22mm 45° blade



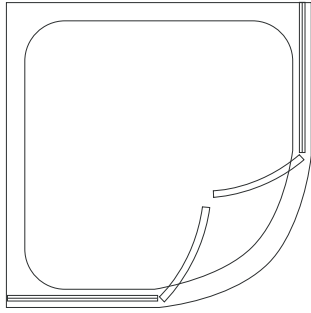

**SHOWER -
Type QL**

Quadrant with double inward opening door

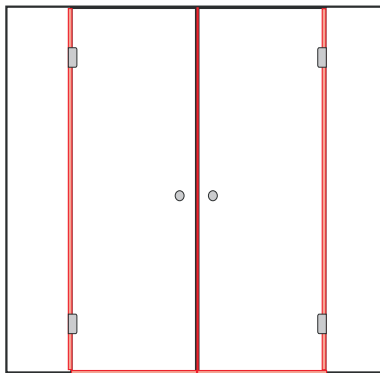
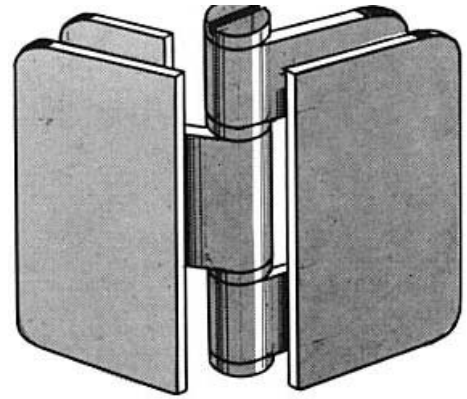

Standard configuration with 8 and 6mm glass

50.QUAD A BASE.--

Provided in kit form:

- 4 x Hinges
- 2 x Knobs
- 4 x Brackets
- 3 x Seals
- 2 x Curved glass doors

Fixed panels are ordered separately to suit shower tray size

Seal options



51.650135.40 Clear bubble



51.636021 Right angle blade



43.PCSL08.40 threshold seal



51.650145.40 soft 'h' seal

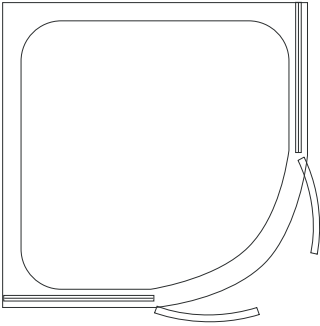

SHOWER - Type QM

Quadrant with double outward
opening door

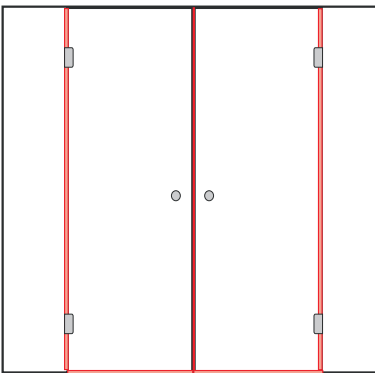
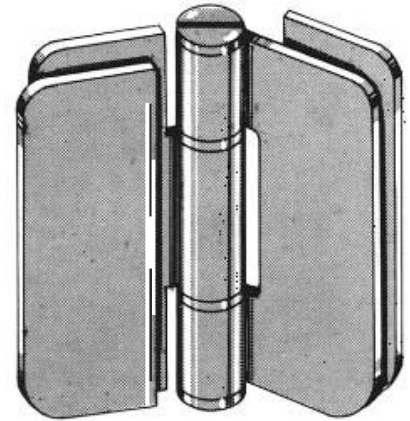

Standard configuration with 8 and 6mm glass

50.QUAD B BASE.--

Provided in kit form:

- 4 x Hinges
- 2 x Knobs
- 4 x Brackets
- 2 x Seals
- 2 x Magnetic seals
- 2 x Curved glass doors

Fixed panels are ordered separately to suit shower tray size

Seal options

51.650135.40 Clear bubble

51.636021 Right angle blade

43.PCSL08.40 threshold seal

51.650145.40 soft 'h' seal

51.632696 magnet - straight



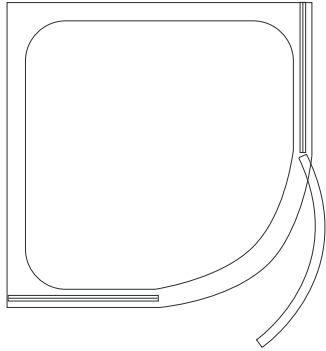

**SHOWER -
Type QM**

**Quadrant with single outward
opening door**

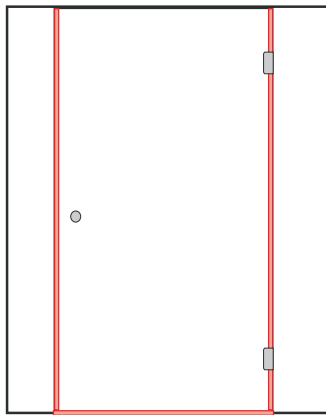
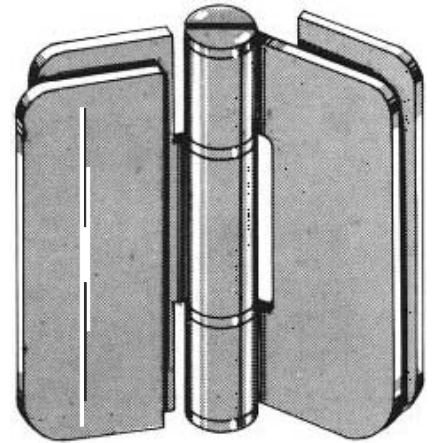

Standard configuration with 8 and 6mm glass

50.QUAD C BASE.--

Provided in kit form:

- 2 x Hinges
- 1 x Knob
- 4 x Brackets
- 1 x Seals
- 2 x Magnetic seals
- 1 x Curved glass door

Fixed panels are ordered separately to suit shower tray size

Seal options



51.650135.40 Clear bubble



51.632696.40 Magnetic seal - straight

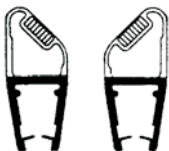

51.633945.40 Magnetic seal 45° S-N

51.633925.40 Magnetic seal 45° N-S

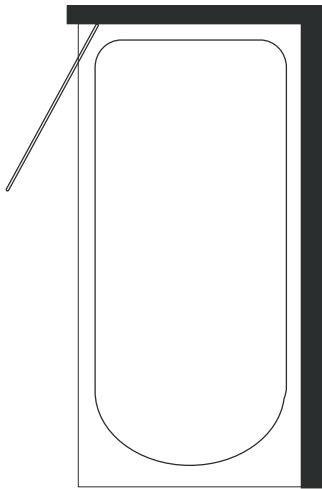

BATH - Type QP

Outward opening screen to
bath width less 50mm

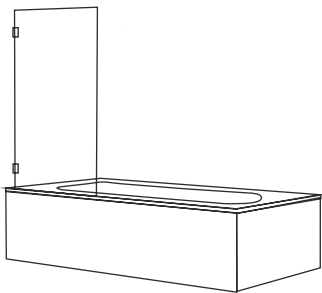
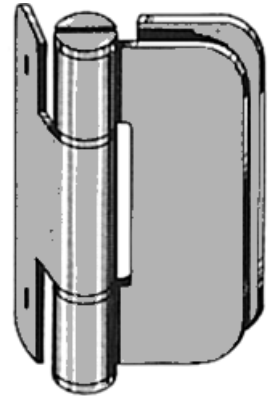

Standard configuration for 8mm glass

2 x 50.0005.--	Wall to glass outward opening hinge
2 x 51.650135.40	Vertical seal hinge edge
1 x 43.PCSL08.40	Threshold seal

Due to the difficulty in gaining watertight sealing to the wall with this configuration, we strongly recommend, whenever possible, to purchase Bath Type QR

Seal options

51.650135.40	Clear bubble
51.636021	Right angle blade
43.PCSL08.40	threshold seal
51.650145.40	soft 'h' seal



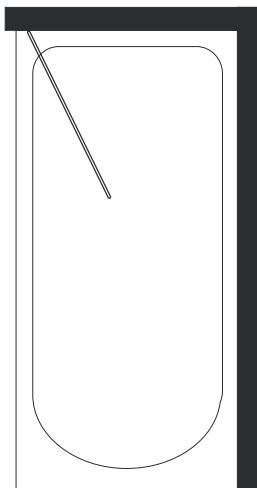

**BATH -
Type QQ**

Inward opening screen to bath
width less 50mm

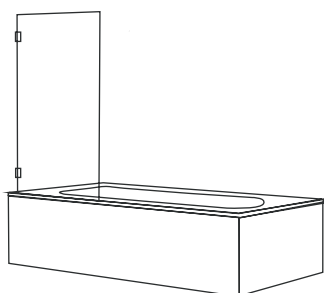
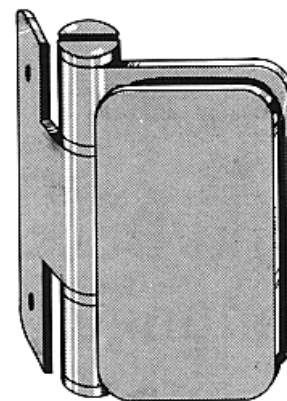

Standard configuration for 8mm glass

2 x 50.0003.--	Wall to glass inward opening hinge
50.70.--	Angle profile
2 x 51.650135.40	Vertical seal hinge edge
1 x 43.PCSL08.40	Threshold seal

Seal options

51.650135.40	Clear bubble
51.636021	Right angle blade
43.PCSL08.40	threshold seal
51.650145.40	soft 'h' seal



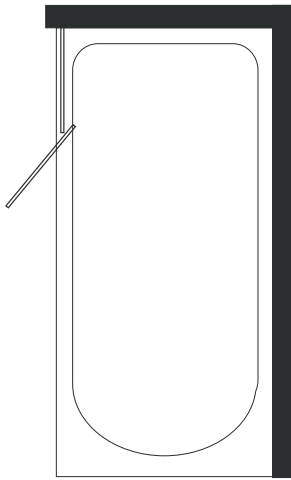

BATH - Type QR

One fixed screen, one outward
opening screen to bath width
less 50mm

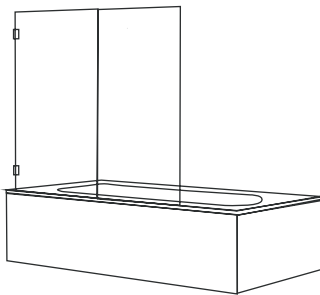
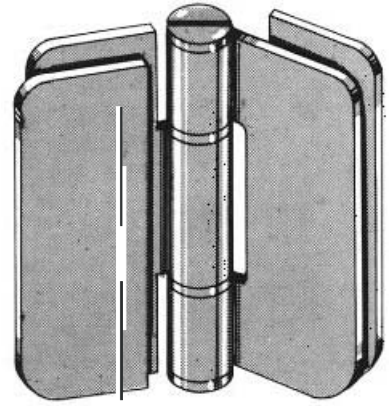

Standard configuration for 8mm glass

2 x 50.0001.--	Glass to glass overlapping hinge
2 x 50.0012.--	Wall brackets
1 x 51.636021.40	Seal to hinge edge of door
2 x 51.650145.40	seal to underside of door

Seal options

51.650135.40	Clear bubble
51.636021	Right angle blade
43.PCSL08.40	threshold seal
51.650145.40	soft 'h' seal



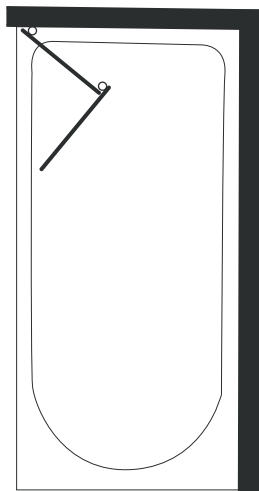

**BATH -
Type QS**

Inward opening bi-fold screen
to maximum width of 1200mm

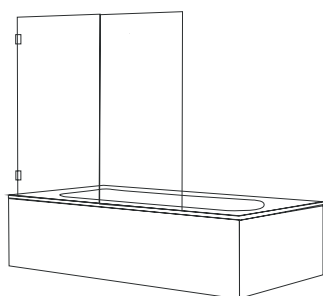
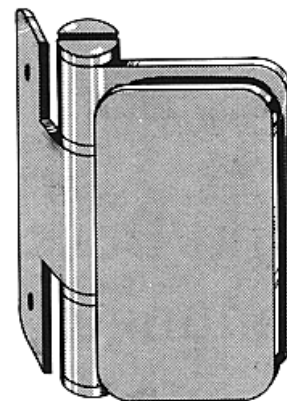

Standard configuration for 8mm glass

2 x 50.0001.--	Glass to glass overlapping hinge
2 x 50.0003.--	Wall to glass inward opening hinge
50.70.--	Angle profile
1 x 51.650135.40	Vertical seal to wall
1 x 51.636021.40	Vertical seal to overlap
1 x 51.650145.40	Seal to underside of screen

Seal options

51.650135.40	Clear bubble
51.636021	Right angle blade
43.PCSL08.40	threshold seal
51.650145.40	soft 'h' seal



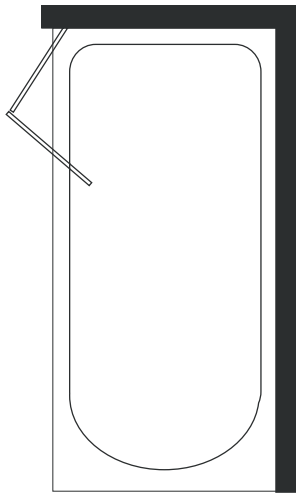

BATH - Type QT

Outward opening bi-fold screen
to width up to 1200mm

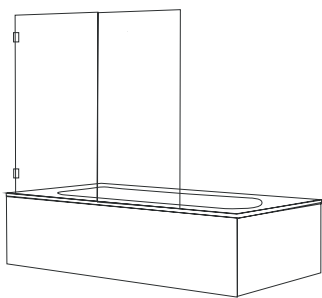
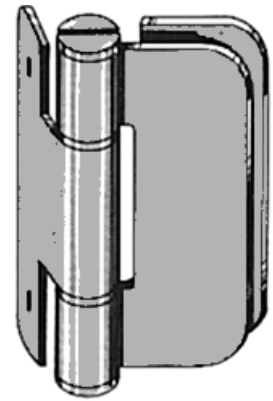

Standard configuration for 8mm glass

2 x 50.0005.--	Wall to glass outward opening hinge
2 x 50.0009.--	Glass to glass in-line hinges
3 x 51.650135.40	Seals to wall and middle vertical of screen
1 x 51.650145.40	seal to underside of door

Seal options

51.650135.40	Clear bubble
51.636021	Right angle blade
43.PCSL08.40	threshold seal
51.650145.40	soft 'h' seal



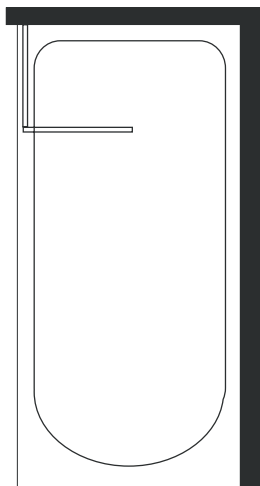

**BATH -
Type QV**

One fixed screen, one inward opening screen to bath width less 50mm

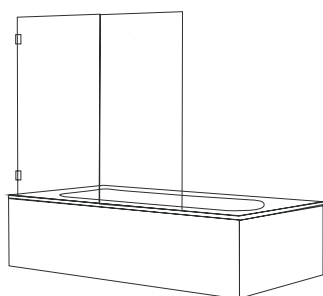
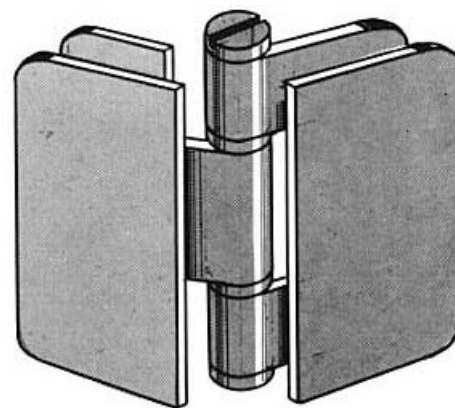

Standard configuration for 8mm glass

2 x 50.0009.--	Glass to glass inward opening hinge
2 x 50.0012.--	Wall brackets
1 x 51.650135.40	Seal to hinge edge of door
2 x 51.650145.40	seal to underside of door

Seal options



51.650135.40	Clear bubble
--------------	--------------



51.636021	Right angle blade
-----------	-------------------



43.PCSL08.40	threshold seal
--------------	----------------



51.650145.40	soft 'h' seal
--------------	---------------

ACCESSORIES

- Brackets

Stainless steel range



- 50.0010.-- Angle bracket, small - wall to glass - 90°
- 50.0010.135.-- Angle bracket, small - wall to glass - 135°
- 50.0010.180.-- Bracket, small - wall to glass - 180°



- 50.0011.-- Angle bracket, small - glass to glass - 90°
- 50.0011.135.-- Angle bracket, small - glass to glass - 135°
- 50.0011.180.-- Bracket, small - glass to glass - 180°

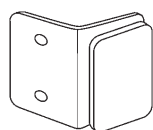

- 50.0012.-- Angle bracket, large - glass to glass - 90°
- 50.0012.135.-- Angle bracket, large - wall to glass - 135°
- 50.0012.180.-- Bracket, large - wall to glass - 180°



- 50.0013.-- Angle bracket, large - glass to glass - 90°
- 50.0013.135.-- Angle bracket, large - glass to glass - 135°
- 50.0013.180.-- Bracket, large - glass to glass - 180°

Brass plated range

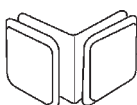

- 43.EST111.-- Suitable for Pinnacle and Grande hinges

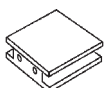

- 43.SGCU1.-- Suitable for Concorde and Geneva hinges



- 43.BGCU1.-- Suitable for Pinnacle and Grande hinges



- 43.GE90S.-- Suitable for Geneva hinges

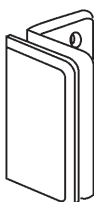

- 43.PI90S.-- Suitable for Pinnacle hinges

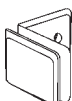

- 43.GR90S.-- Suitable for Grande hinges

Accessories

- Single action hinges: stainless steel

Multi-option variable positioning mechanism available.
See page 30 for finishes

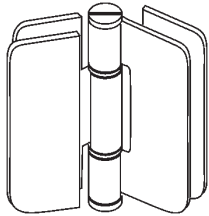

50.0001.--
Glass to glass,
overlapping, 180°

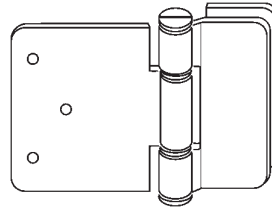

50.0007.--
Wall to glass, long wall plate,
outward, 90°

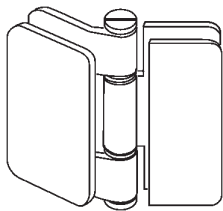

50.0002.--
Glass to glass,
overlapping, 180°

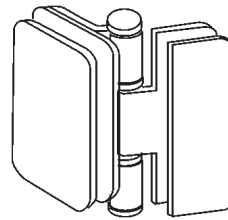

50.0008.--
Glass to glass, inward, 180°

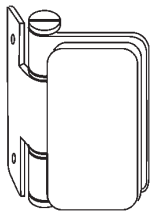

50.0003.--
Wall to glass, inward, 90°

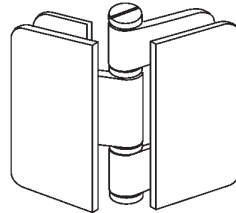

50.0009.--
Wall to glass, inward, 90°

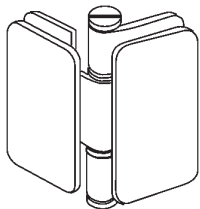

50.0004.--
Glass to glass, inward, 90°

50.0004.135.--
Glass to glass, inward, 135°

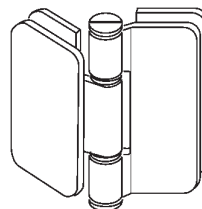

50.0106.--
Glass to glass, outward, 135°

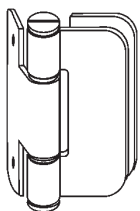

50.0005.--
Wall to glass, outward, 90°

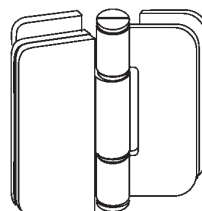

50.0101.135.--
Glass to glass, outward, 225°

50.0101.180.--
Glass to glass, outward, 180°

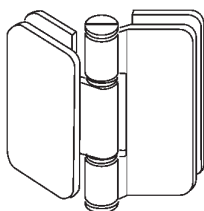

50.0006.--
Glass to glass, outward, 90°

Accessories

- Double action hinges: Brass

Self centring within 15° of closed. Solid brass, electro-plated. Please see page 31 for finishes.



Concorde hinge series

For 10 or 12mm glass. Up to 36kg or 711mm wide per pair.

43.SDH037.--	wall to glass
43.SDH180.--	glass to glass - 180°
43.SDH045.--	glass to glass - 135°
43.SDH090.--	Glass to glass - 90°

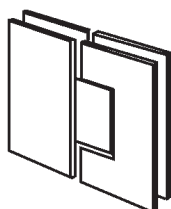

Geneva hinge series

For 10 or 12mm glass. Up to 36kg or 711mm wide per pair.

43.GEN044.--	wall to glass
43.GEN180.--	glass to glass - 180°
43.GEN045.--	glass to glass - 135°
43.GEN090.--	Glass to glass - 90°

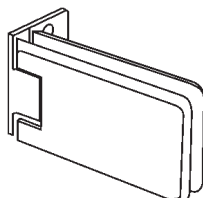

Grande hinge series

For 8 or 10mm glass. Up to 41kg or 787mm wide per pair.

43.GEN044.--	wall to glass
43.GEN180.--	glass to glass - 180°
43.GEN135.--	glass to glass - 135°
43.GEN090.--	Glass to glass - 90°

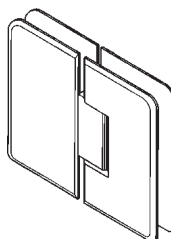

Cologne hinge series

For 10 or 12mm glass. Up to 50kg or 914mm wide per pair.

43.COL037.--	wall to glass
43.COL180.--	glass to glass - 180°
43.COL135.--	glass to glass - 135°
43.COL092.--	Glass to glass - 90°

Accessories

- Knobs and Handles

Stainless steel

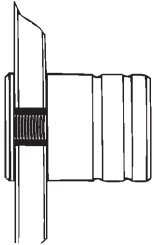

50.0244HLF.--
Single sided for bi-fold doors

Ø40 single sided, polished, brushed or RAL colour powder coated

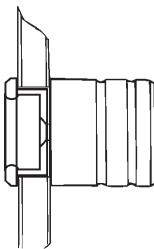

12.50.0244.--
Single with finger pull for bi-fold doors

Ø40 single sided, polished, brushed or RAL colour powder coated

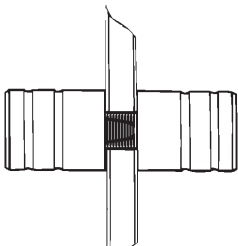

50.0230.--
Back to back

Ø30, polished, brushed or RAL colour powder coated

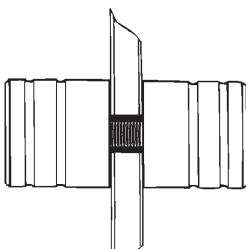

50.0244.--
Back to back

Ø40, polished, brushed or RAL colour powder coated

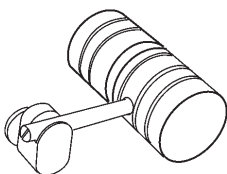

12.50.03.--
Quarter turn latch

Ø40, with emergency release. Polished, brushed.
Keeps for in-line, overlapping, tiled wall or glass partition also available.

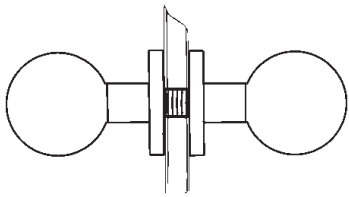

50.0250.--

Ball

Ø50 back to back, polished, brushed.

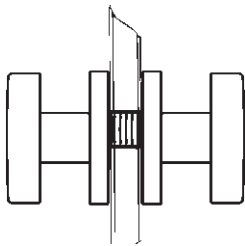

50.0255.--

Flat ended

Ø50 back to back, polished, brushed.

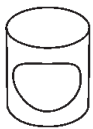

39.1126.--

Finger pull

Ø20, Ø25, Ø30 back to back, polished, brushed.

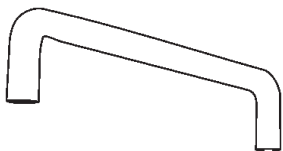

39.191.xxx.--

Loop 'D' handle bar

Ø19, length 108 - 1200mm, back to back or single sided. Stainless steel or brass, polished, brushed.

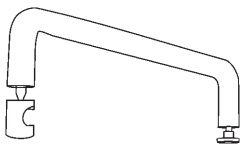

12.50.10.xxx.--

Combined knob and towel bar

Ø19 'D' handle, knob and fixing screw. Available in 425mm and 600mm lengths. Stainless steel or brass, polished or brushed.

Accessories

- Metal Profiles



50.70.--
Angle 25 x 30mm

Up to 2m (length over 2m can be fabricated in stainless steel only). Aluminium - silver anodised or RAL coated.
Stainless steel - brushed, polished, velour or RAL coated.



50.71.--
Channel 20 x 17mm

Up to 2m (length over 2m can be fabricated in stainless steel only). Aluminium - silver anodised or RAL coated.
Stainless steel - brushed, polished, velour or RAL coated.



50.73.--
'F' Support

Up to 2m (length over 2m can be fabricated in stainless steel only).
Stainless steel - brushed, polished, velour or RAL coated.



50.74.--
Support Profile

Up to 2m (length over 2m can be fabricated in stainless steel only).
Stainless steel - brushed, polished, velour or RAL coated.



50.76.--
Box 20 x 15mm

Up to 2m (length over 2m can be fabricated in stainless steel only). Aluminium - silver anodised or RAL coated.
Stainless steel - brushed, polished, velour or RAL coated.

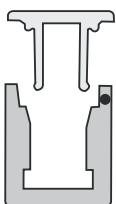

50.78B.21
Aluminium Capping

Up to 4m. Silver anodised. Creating a box 20 x 25mm high

50.78A.21
Aluminium Channel 20 x 23mm

Silver anodised.

Accessories

- Clear Seals



51.632826.40

6-8mm glass

51.650135.40

8-10mm glass

Bubble

2.5m lengths.

For hinge edge of doors and threshold applications.



43.PCB06.40

6mm glass

51.636021.40

8mm glass

Right angle blade

2m lengths.

For overlapping edge of doors.



51.60338.40

6-8mm glass

51.650145.40

8-10mm glass

Soft 'h'

2.5m lengths.

For vertical and threshold applications.



50.0401.030-...40

8mm glass

50.0501.030-...40

10mm glass

Sweep seal

2m lengths.

For some overlap and threshold applications. Inserts available in 10 or 22mm length, straight or 45°.



43.PCC08.40

43.PCC10.40

8 or 10mm glass

Short soft 'h'

2.4m lengths.

For vertical and threshold applications.



51.636394.40

6-8mm glass

Seal and stop

2.5m lengths.

For vertical applications.



43.PCSL06.40

43.PCSL08.40

43.PCSL10.40

43.PCSL12.40

6, 8, 10 or 12mm glass

Bottom wipe and drip rail

2.4m lengths.

For threshold applications.



43.PCS06.40

43.PCS08.40

43.PCS10.40

43.PCS12.40

6, 8, 10 or 12mm glass

Bottom wipe and drip rail

2.4m lengths.

For horizontal and vertical applications.



51.632696.40

6-8mm glass

51.650270.40

8-10mm glass

Magnetic seal straight

2.5m lengths.

For outward opening door pairs



51.633945.40 (S-N)

6-8mm glass

51.650250.40 (S-N)

8-10mm glass

51.633945.40 (N-S)

6-8mm glass

51.650250.40 (N-S)

8-10mm glass

Magnetic seal 45°

2.5m lengths.

Accessories

- Stabilisers, Door Stop and Leg

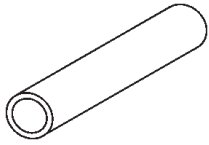

50.77.--

Tube

Ø16, stainless steel - brushed, polished.

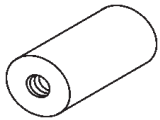

12.50.01.--

End connector

For wall fixing.
Stainless steel - brushed, polished.

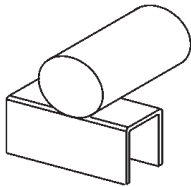

12.50.14.--

End connector with channel

For glass fixing.
Stainless steel - brushed, polished.

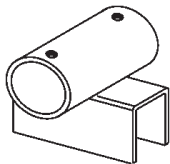

12.50.02.--

'T' connector

Stainless steel - brushed, polished.



12.50.13.--

Door stop 49 x 15mm

For UV bonding applications. Also available for wall fixing.
Stainless steel - brushed, polished.



12.50.09.--

Leg, for partitioning

Available with channel or bracket for glass or plate for wall board.
For minimum 8mm glass.
Standard height 150mm.
Stainless steel - brushed or polished.

NOTES:

MATERIAL AND SURFACE FINISHES:

Material	Finish	Code
Aluminium	Bright anodised	12
	Silver anodised	21
	Stainless steel effect	24
Stainless Steel	Brushed	31
	Polished	32
	Velour	33
	Gold plated	34
	RAL 9010 White	36
	RAL coated	38
Plastic	Clear	40
Brass	Brushed	74
	Polished chrome	75
	Polished, lacquered	80
	Brushed nickel plate	84
	Chrome velour	85
	RAL 9010 white	86
	RAL 9016 white	87
	RAL coated	88
	Other electro-plated finish	89

When specifying or ordering items from this catalogue please substitute the – suffix with the code of your required finish